

Whatman™ FTA Elute™

Long-term DNA preservation at room temperature combined with easy elution for multiple applications from a single sample

Part of the Whatman family of innovative FTA products, Whatman FTA Elute provides a new level of speed and convenience for your DNA research. FTA Elute combines long-term room temperature DNA preservation with easy elution, allowing you to create multiple amplifications from a single sample. In fact, FTA Elute provides as much as 100 µl of DNA template from just one punch. The eluted DNA can be measured quantitatively with commercially available kits. Imagine not having to rely on expensive freezer systems for your DNA archiving. Now you can collect samples easily, store them at room temperature and release DNA into solution with a simple water and heat elution step.

Applications

- Biobanking
- Genotyping
- Transgenics
- Pharmacogenomics
- Rapid DNA isolation
- Genetic identification
- PCR

Advantages	Benefits
Samples can be collected, shipped and stored at room temperature	<ul style="list-style-type: none"> • Eliminates high costs associated with shipping samples on ice • Eliminates high costs associated with laboratory freezer storage requirements
Sample processing time to isolate DNA is 5-30 minutes	<ul style="list-style-type: none"> • Eliminates lengthy and multiple step isolation procedure (4-16 hours)
Sample processing requires a simple water elution procedure to isolate DNA	<ul style="list-style-type: none"> • Eliminates cost of using a purification kit
Sample volume requirements handling/processing are minimal: 12-40 µl per collection area	<ul style="list-style-type: none"> • Eliminates venous blood samples and large blood volume • Eliminates the need for venipuncture equipment and medical attendant at the site of collection
Hemoglobin, a known PCR inhibitor, is bound to the FTA Elute matrix	<ul style="list-style-type: none"> • Yields DNA free of PCR inhibitors

Collect and isolate samples quickly and easily

Blood sample collection and isolation of DNA template

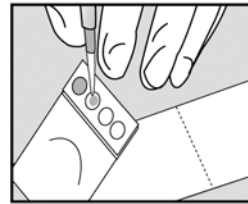

1. Blood sample collection on FTA Elute. Dry thoroughly.

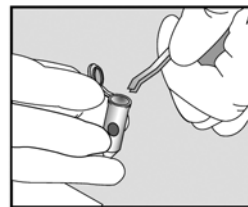

2. Punch out a 3 mm sample with a sterile punch and place into a sterile microcentrifuge tube.

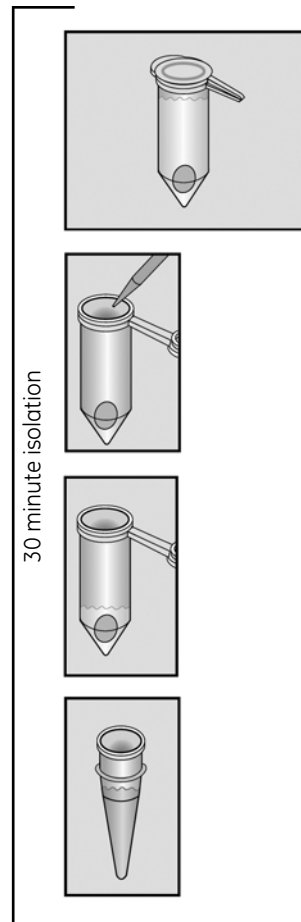

30 minute isolation

3. Rinse punch in 500 µl of dH₂O by vortexing 3 times for 5 seconds.

4. Using a sterile pipette, remove water; centrifuge 5 seconds; pipette off excess.

5. Add 50 µl sterile water; heat to 95°C for 30 minutes. Remove the sample from the block and pulse vortex or gently tap the sample approximately 60 times. Centrifuge for 30 seconds to separate the matrix from the eluate, which now contains the purified DNA. Remove the disc using a sterile pipette tip and discard.

6. Add 5-10 µl template to PCR reaction mixture.



The rapid identification of tens of thousands of human genes and hundreds of thousands of DNA variations that may influence disease susceptibility has created the field of pharmacogenomics. Pharmacogenomic companies are involved in quantifying and cataloguing human genetic variation and using algorithms to tease out correlations among biomarkers, genes, diseases and drug response with the promise of personalized medicine.

SNP Genotyping is at the heart of pharmacogenomics and personalized medicine. SNP Genotyping, comparative DNA analysis, is utilized for determining the predisposition of individuals to certain diseases or medical disorders. SNPs are also found in genes for drug-metabolizing enzymes, thus influencing an individuals' ability to process a drug properly. By linking specific diseases with specific SNPs, potential drug targets may be developed for personalized therapy.

There are many methods by which genotyping may be performed. Sequencing, TaqMan™, Molecular Probes (Invitrogen), mass extension, agarose gel electrophoresis and Scorpions™ ARMS™ technology are among the most common methods to perform genotyping analyses.

FTA Elute not only provides a simple purification methodology but also provides high quality DNA for a multitude of applications — from biobanking, pharmacogenomics to genotyping to diagnostics.

The following experiments were conducted: Real Time PCR, Whole Genome Amplification, Sequencing, Multiplex Gene Deletion Assay, ARMS Scorpions Genotyping and Scorpions ASO Genotyping. The results from these experiments clearly demonstrate the high quality of DNA obtained from FTA Elute.

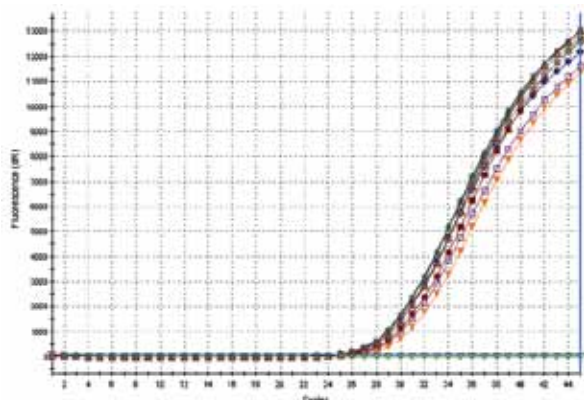

Fig 1. Real time PCR plots of 10 test samples. Ten individual samples of DNA purified using FTA Elute were prepared for real time PCR of an in-house reference DNA fragment. For this assay 2.5 µl of the extracted DNA was mixed with the DNA binding dye Yo-Pro 1 (Invitrogen) to monitor real-time PCR Amplification. A no template control was included in the assay and appears as the flat line at the bottom of the profile.

Real time PCR†

DNA eluted from the FTA Elute punches was subjected to quantitative PCR to demonstrate the quality of the purified DNA. Blood samples were collected from 10 separate individuals onto FTA Elute cards and the cards were allowed to dry completely.

Punches (3.0 mm) were extracted according to the water and heat elution protocol in a final volume of 100 µl. Approximately 2.5 µl of the purified DNA was added to the real time PCR mixture and amplified using the Yo-Pro 1 DNA binding dye (Invitrogen). Fig 1 shows a very tight grouping of curves with an average Ct of 26.58 which equals 22.14 ng of DNA in the 100 µl final volume. Considering the samples are from 10 individuals any variability seen in the Ct values are due to individual variability (as would be seen in a white blood cell count). The data is highly reproducible from the 10 individual samples showing the high quality of DNA purified using FTA Elute. The yield of DNA from FTA Elute is sample dependent. For blood, over a large number of different determinations, yields ranges are 55–70%. For buccal, over a large number of different determinations, yield is generally higher, 60–75%. The easy extraction procedure also demonstrates that the DNA obtained is amenable to high throughput genotyping.

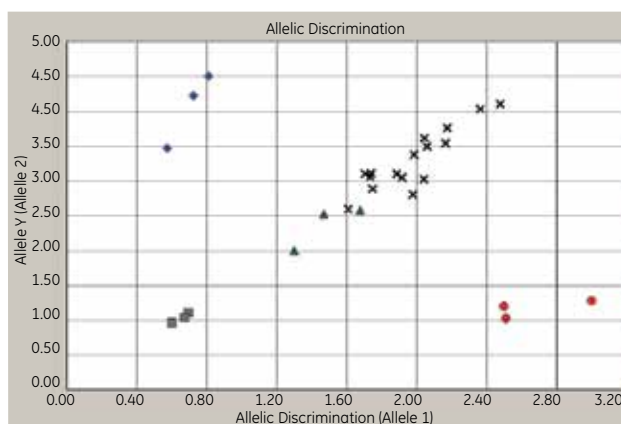
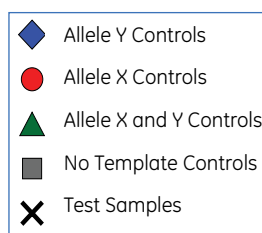

Fig 2. TaqMan genotyping of whole genome amplified DNA from FTA Elute.



DNA was purified from whole blood spots stored for 0, 2 and 8 years on FTA Elute and amplified by REPLI-g™ methods. The amplified DNA was then genotyped for a single SNP in replicates of 5 and compared to authentic genomic DNA controls.

Whole genome amplification

DNA purified from blood on FTA Elute was subjected to whole genome amplification (WGA) using the REPLI-g (Qiagen) method. The amplified DNA then underwent genotyping with the TaqMan method (Fig 2). There is excellent allelic discrimination obtained with this method. Blood spots dried on FTA Elute for 0, 2 and 8 years served as templates for WGA and the DNA amplified from the FTA Elute was then analyzed for SNP 1004. The WGA DNA performed in genotyping assays as well as authentic genomic DNA purified by other methods. These results demonstrate that DNA stored and purified from FTA Elute can serve as an unlimited supply of DNA for current and future genotyping studies.

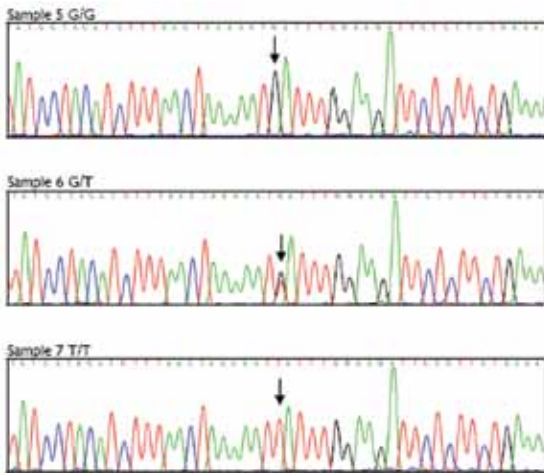

Fig 3. Genotyping by DNA sequencing . DNA samples from FTA Elute were used to amplify a 1.05 kb exon 1 fragment of the UGT2B15 gene. The PCR product was treated with ExoSAP-IT™ (USB). Sequencing reactions using ABI Big Dye™ v 1.1 were carried out on an MJ Research Tetrad™ instrument. Sequencing reactions were cleaned up using ABgene Dye Terminator Removal Kits and run on an ABI Prism™ 3100 instrument.

Sequencing†

DNA sequencing is the “gold standard” for detecting polymorphisms in gene sequences. In order to demonstrate the quality of the DNA eluted from FTA Elute, a 1.05 kb fragment from exon 1 of the 2B15 variant of the UDP-glucuronosyltransferase (UGT) gene was amplified by PCR, then subjected to sequencing. DNA from 10 individuals were tested for the G > T polymorphism at the D85Y loci (Table 1). Representations of homozygous wild type G/G, heterozygous wild type/ mutant G/T and homozygous mutant T/T base pair changes are shown in Fig 3; the positions of the polymorphisms are indicated by an arrow. The profile indicates that the DNA extracted from FTA Elute yields excellent sequencing data. The peaks are clean, well defined and show high quality delineation.

Table 1.

Sample	Genotype
Individual 1	G/G
Individual 2	T/T
Individual 3	G/T
Individual 4	G/G
Individual 5	G/G
Individual 6	G/T
Individual 7	T/T
Individual 8	G/G
Individual 9	T/T
Individual 10	G/G

Multiplex gene deletion assay†

Many labs perform multiplex gene deletion assays using end-point PCR and agarose gel electrophoresis as a means of genotyping. The presence or absence of bands for a large deletion is clearly visible on the gels. Fig 4 shows a multiplex PCR performed with DNA purified from FTA Elute to detect a deletion in the UGT2B17 gene. The wild type and mutant genes are demonstrated by bands of 316 bp and 884 bp, respectively. As can be seen the individual in lane 7 is homozygous for the mutant form of the gene.

The ability to multiplex with multiple primers is dependent on high quality DNA to prevent mis-priming and non-specific banding patterns. The DNA purified by FTA Elute is very robust and less than 1 ng is required to yield clean strong bands in the multiplex PCR.



Fig 4. Multiplex gene deletion assay for UGT2B17 deletion assay—multiplex PCR genotyping. Amplicons from a multiplex PCR were separated on a 1.5% Agarose gel. Lanes 1–10 are reactions using DNA from 10 separate individuals. The control lanes demonstrate the possible genotypes: A wt/wt; B wt/mut; C mut/mut. The Abgene Electrofast MWMarker Ladder: 250 bp, 500 bp, 1000 bp is in Lanes M.

ARMS Scorpions genotyping†

Amplification Refractory Mutation System (ARMS™) and Scorpion™ probes is a homogeneous platform for molecular analysis and genotyping. It is a very sensitive system detecting only a few molecules of interest even in the presence of high background. This platform is fast and excellent for detecting difficult sequence stretches such as high GC content.

Blood samples from 10 individuals were collected onto FTA Elute matrix and processed for genotyping analysis of the UGT2B15*2 gene. The samples were run in sets of 4 replicates and plotted as a function of the fluorescence of the two dyes HEX and FAM. Fig 5 shows a clear distinction between heterozygous and homozygous samples. This type of data demonstrates that FTA Elute yields a very clean DNA template that is reproducible and excellent for use with the highly sensitive ARMS Scorpions technology.

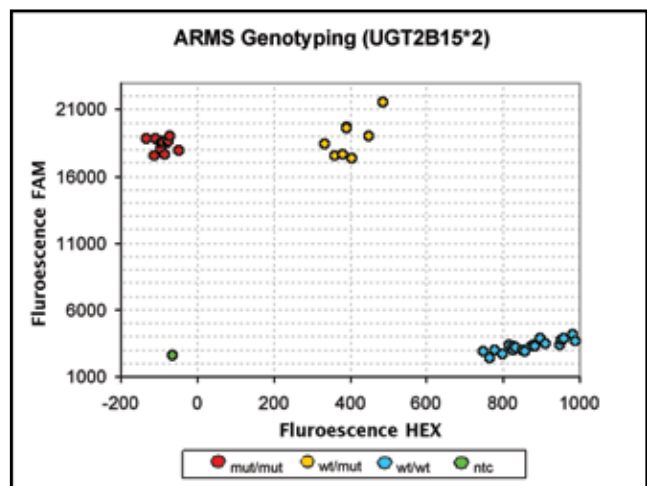

Fig 5. ARMS Scorpions genotyping. Genotyping was performed on 4 replicates each of 10 different DNA samples purified on FTA Elute. This assay was performed on a Stratagene Mx3000P® Real-time PCR machine. ARMS Scorpion assays use the specificity of ARMS combined with the signaling of Scorpion probes to generate data. Fluorescence readings were taken pre- and post-PCR. The data shows 3 discrete genotype populations: mut/mut, wt/mut, wt/wt. NTC refers to no template control. from a multiplex PCR were separated on a 1.5% Agarose gel. Lanes 1–10 are reactions using DNA from 10 separate individuals. The control lanes demonstrate the possible genotypes: A wt/wt; B wt/mut; C mut/mut. The Abgene Electrofast MWMarker Ladder: 250 bp, 500 bp, 1000 bp is in Lanes M.

Scorpions ASO genotyping†

Another technology for genotyping is using allele specific oligonucleotide (ASO) probes in conjunction with the Scorpion homogeneous platform. This method provides the fluorescent tag necessary to monitor real time PCR while the ASO supplies the quencher. This method is similar to other existing methods of genotyping like Molecular Beacons, TaqMan and other probe based methods of genotyping. Fig 6 shows 10 separate DNA samples from blood collected on FTA Elute and purified by a simple water heat elution method. The data separates out into clear groupings of heterozygous and homozygous samples for the NAT2*5 gene. These results show that the DNA purified by FTA Elute is compatible with all major means of real time PCR based genotyping and can be included in high throughput genotyping operations.

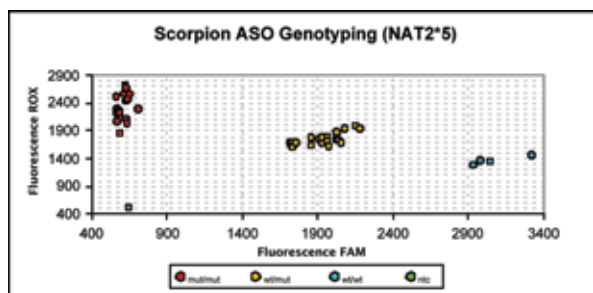

Fig 6. ASO genotyping.

Genotyping was performed on 4 replicates each of 10 different DNA samples purified on FTA Elute. This assay was performed on a Stratagene Mx3000P Real-time PCR machine. ASO Scorpion assays use the specificity of allele specific probes combined with fluorescence signalling to generate data. Fluorescence readings are taken pre and post-PCR.

Whatman FTA Elute—key to high quality DNA

If your goal is to obtain pure, high quality DNA free of inhibitors for your critical research, then Whatman FTA Elute will be an invaluable addition to your DNA toolbox. DNA purified with FTA Elute is suitable for a wide variety of molecular applications.

www.gelifesciences.com/whatman

GE Healthcare UK Limited
Amersham Place
Little Chalfont
Buckinghamshire, HP7 9NA, UK



GE imagination at work

Recommended protocol

This protocol is recommended if you need a large amount of DNA. If your testing does not require a lot of DNA, then typically you can use one 3 mm punch and follow the protocol on page 1.

- 1) Punch 3 circles from the centre of a blood spot using a 3.0 mm paper punch into a sterile 1.5 ml microfuge tube. To prevent cross contamination between samples, punch a clean piece of filter paper 3 times after punching out each sample.
- 2) Wash the punched circles by adding 500 µL of sterile water to the tube and pulse vortex 3 times, for a total of 5 seconds. Please note: If the wash is pink, the blood sample was not completely dried. Discard these punches and thoroughly dry the remaining blood spots before re-punching the card and repeating step 2.
- 3) Using a sterile pipette remove excess wash water from the tube and gently squeeze the circles against the side of the tube to remove as much water as possible.
- 4) Add 100 µl of sterile water to the tube. Ensure the circles are completely immersed in the water by briefly pulse centrifuging the tube for 5 seconds.
- 5) Transfer the tube to a heating block at 95°C-100°C for 15-30 minutes.
- 6) At the end of the incubation period remove the sample from the block and pulse vortex the sample approximately 60 times.
- 7) Briefly centrifuge to separate the paper punch from the eluant. The eluant now contains the extracted DNA.
- 8) Using a sterile pipette tip gently remove the spent blood spot circles from the tube and discard them into a biohazard container.
- 9) Store the eluted DNA at -20°C until required.

† Experiments referenced in this application note were conducted by DxS Limited.

Ordering information

Catalog number	Description	Quantity/pack
WB120410	FTA Elute Micro Card	100
WB120401	FTA Elute Micro Card	25

GE, imagination at work and GE monogram are trademarks of General Electric Company.

*FTA, FTA Elute, and Whatman are trademarks of GE Healthcare companies.

© 2011 General Electric Company – All rights reserved.
Previously published December 2006.

All goods and services are sold subject to the terms and conditions of sale of the company within GE Healthcare which supplies them. A copy of these terms and conditions is available on request. Contact your local GE Healthcare Representative for the most current information.

GE Healthcare Bio-Sciences AB
Björkgatan 30
751 84 Uppsala
Sweden

GE Healthcare Europe, GmbH
Munzinger Strasse 5
D-79111 Freiburg
Germany

GE Healthcare Bio-Sciences Corp.
800 Centennial Avenue
Piscataway, NJ 08855-1327
USA

GE Healthcare Japan Corporation
Sanken Bldg., 3-25-1, Hyakunincho
Shinjuku-ku, Tokyo 169-0073
Japan